

The Faster, Smarter, More Efficient

KIP 900 | COLOR SERIES



**SYSTEM K
SOFTWARE**

KIP 970

KIP 980

KIP 990

The Faster, Smarter, More Efficient

KIP 900 | COLOR SERIES

Faster The most advanced high demand wide format color print system, delivers consistent productivity.

Smarter Brilliant multi-tasking with KIP Smart multi-function touchscreen and KIP Image Pro software, which is intelligently integrated with all KIP Accessories.

More Efficient KIP 900 Series technology lowers operating costs.

SIGNATURE FEATURES:

Productivity

- Color Printing - 5,760 Sq. Ft. per Hour
- Black & White Printing 7,200 Sq. Ft. per Hour
- KIP ImagePro

Design

- 4 Roll with 7,800 Sq. Ft. Media Capacity
- High Capacity Toner Cartridges
- Professional Edge Alignment Stacking

Configurations

- High Demand Dual Footprint Design
- Production or Convenience Scanning

The cutting edge just got a lot sharper!





HIGH DEMAND CONSISTENT PRODUCTIVITY

Engineered to deliver:

- Superb Print Quality
- Reliable Performance
- Efficient Operation
- Remarkable Value

The KIP 900 Color Series systems are designed for print centers that require high demand output, precise imaging and bold, expressive color fidelity.

KIP 900 Color Series systems produce amazingly vibrant colors, subtle tints and hues with unsurpassed color stability from the first to final print.

All prints and copies generated by the KIP 900 Color Series systems deliver the highest image durability and are fully lightfast; they will not fade or exhibit color deterioration from exposure to light over extended periods. The CMYK dry toner system employed by the KIP 900 Color Series produces 100% waterproof images that are suitable for outdoor applications, even in inclement weather.

The KIP 900 Color Series systems are a comprehensive wide format solution for a range of printing tasks spanning from architectural, engineering and construction documents – to maps, posters and signs – without sacrificing quality or performance.

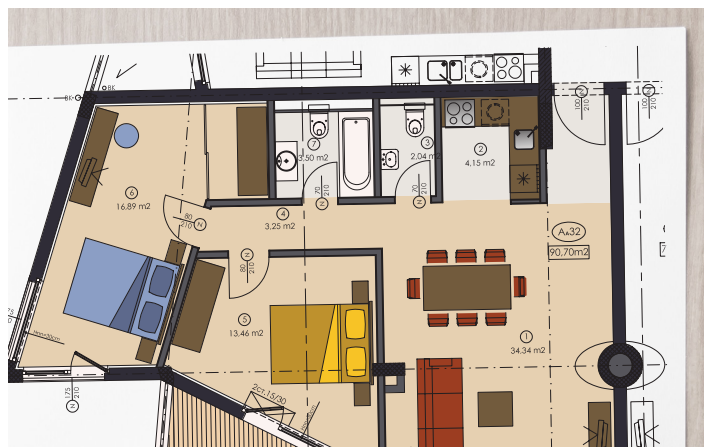
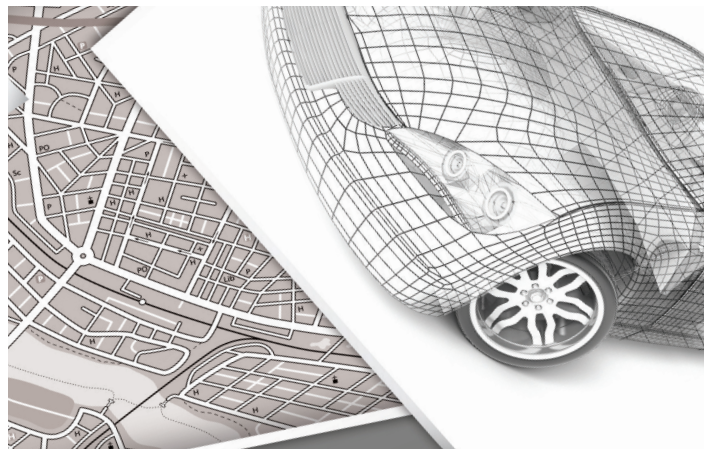
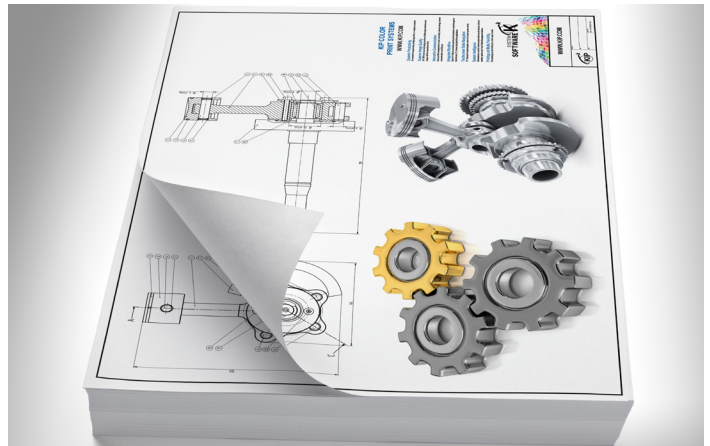



KIP 970



KIP 970

High demand multi-touch color print system

Transforms High Demand Print Efficiency

- High demand network production print system
- 4 x 650 foot rolls
- 7,800 square foot media capacity
- 7,200 square feet per hour black & white productivity
- 5,760 square feet per hour color productivity
- High capacity toner cartridges
- 12" Smart System K multi-function touchscreen
- Professional edge alignment stacking
- KIP System K 2.0 with KIP ImagePro
- Robust build quality for maximum reliability

**HIGH DEMAND
KIP 900 | COLOR SERIES**

KIP 980



KIP 990



KIP 980

High demand color multi-function system

Intelligently Accelerates Productivity

- High demand multifunction production print system with KIP 720 CIS convenience scanner
- 4 x 650 foot rolls
- 7,800 square foot media capacity
- 7,200 square feet per hour black & white productivity
- 5,760 square feet per hour color productivity
- High capacity toner cartridges
- 12" Smart System K multi-function touchscreen
- Professional edge alignment stacking
- KIP System K 2.0 with KIP ImagePro
- Robust build quality for maximum reliability

KIP 990

High demand color multi-function system

Brilliantly Advanced Multifunction Production Performance

- High demand multifunction production print system with KIP 2300 CCD production scanner
- 4 x 650 foot rolls
- 7,800 square foot media capacity
- 7,200 square feet per hour black & white productivity
- 5,760 square feet per hour color productivity
- High capacity toner cartridges
- 12" Smart System K multi-function touchscreen
- Professional edge alignment stacking
- KIP System K 2.0 with KIP ImagePro
- Robust build quality for maximum reliability

High Demand KIP 900 Color Series

TECHNOLOGY HIGHLIGHTS

Consistent Productivity

- Single Pass Black
- Full Color

Professional Edge Alignment Stacker

Enhanced Drivetrain Performance

Page Accuracy

Expanded Media Capacity

High Capacity Toner Cartridges

Permanent High Definition Print Head

Quick Switch Technology

KIP ImagePro Print Management Suite



KIP ImagePro

KIP ImagePro is a single software solution designed to simplify every stage of color and black & white wide format workflow.



Consistent Productivity

High quality single pass black and full color images at consistent print speed. The KIP 900 Series technology lowers operational costs. Print image is lightfast, waterproof and does not smear when using mark-up highlighters.

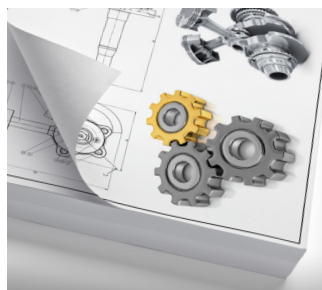

Production Printing

The KIP 900 Color Series print systems offer superb high quality resolution at remarkable consistent print speeds of up to 7,200 square feet or 670 m² per hour, in black & white or 5,760 square feet or 535 m² per hour, in color.



Professional Edge Alignment

Professional edge alignment stacking reduces post printing interaction.

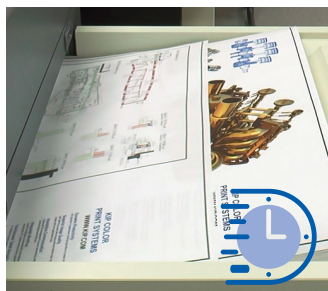

Quick Switch Technology

Mixed print size sets at full production speed. The KIP 900 Color Series print technology eliminates roll switching delays for increased productivity.

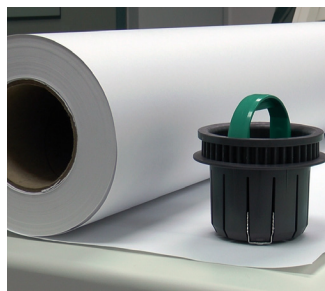

Expanded Media Capacity

An ergonomic roll cap system simplifies the process of loading the 7,800 square foot / 725 m² media capacity.

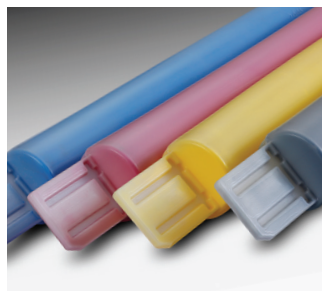

Large Capacity Toner

Each CMYK cartridge contains 1,500 gms of toner for a total capacity of 6,000 gms - allowing longer uninterrupted color and black & white print runs for continuous system productivity.



Automatic Calibration

For color images that compliment the highest standards, an exclusive single belt imaging system performs automatic calibrations for precise imaging and bold, expressive color output.

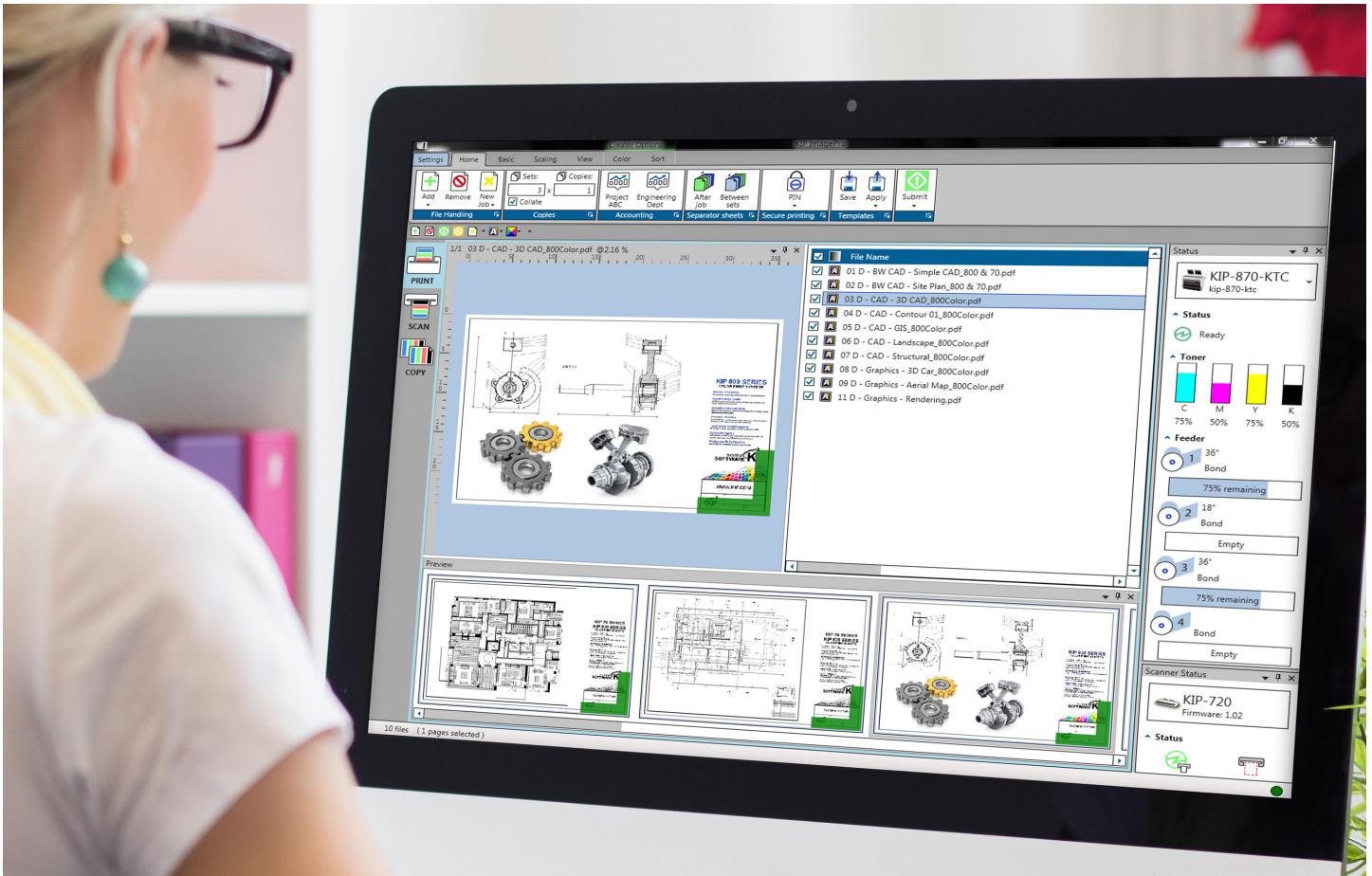

KIP ImagePro is a single software solution designed to simplify every stage of color and black & white wide format workflow.

STANDARD MODE

- Fast and Easy Print Control
- Quick Access Tool Bar
- Column Logic
- High Definition Viewer
- Image Clean Up
- Area of Interest

EXPANDED MODE

Features for Technical Production and Color Graphic Professionals:

- Color Management
- Nest, 2 Up, Paneling
- Job Validation
- Customizable Interface Pop Out
- Flexibility in System Configurations



KIP 70 Series



KIP 70 and KIP Color Series Multi-touch Solutions

- Copy & Scan to Local/USB/LAN/Cloud (MFP)
- Print from Local/USB/LAN/Cloud
- Super View with Area of Interest
- Cloud Connect
- Data Security
- Smart Scan
- KIPFold Control

OPTIONS:

- Removable HD
- Card Reader



MFP

Printer

NETWORK

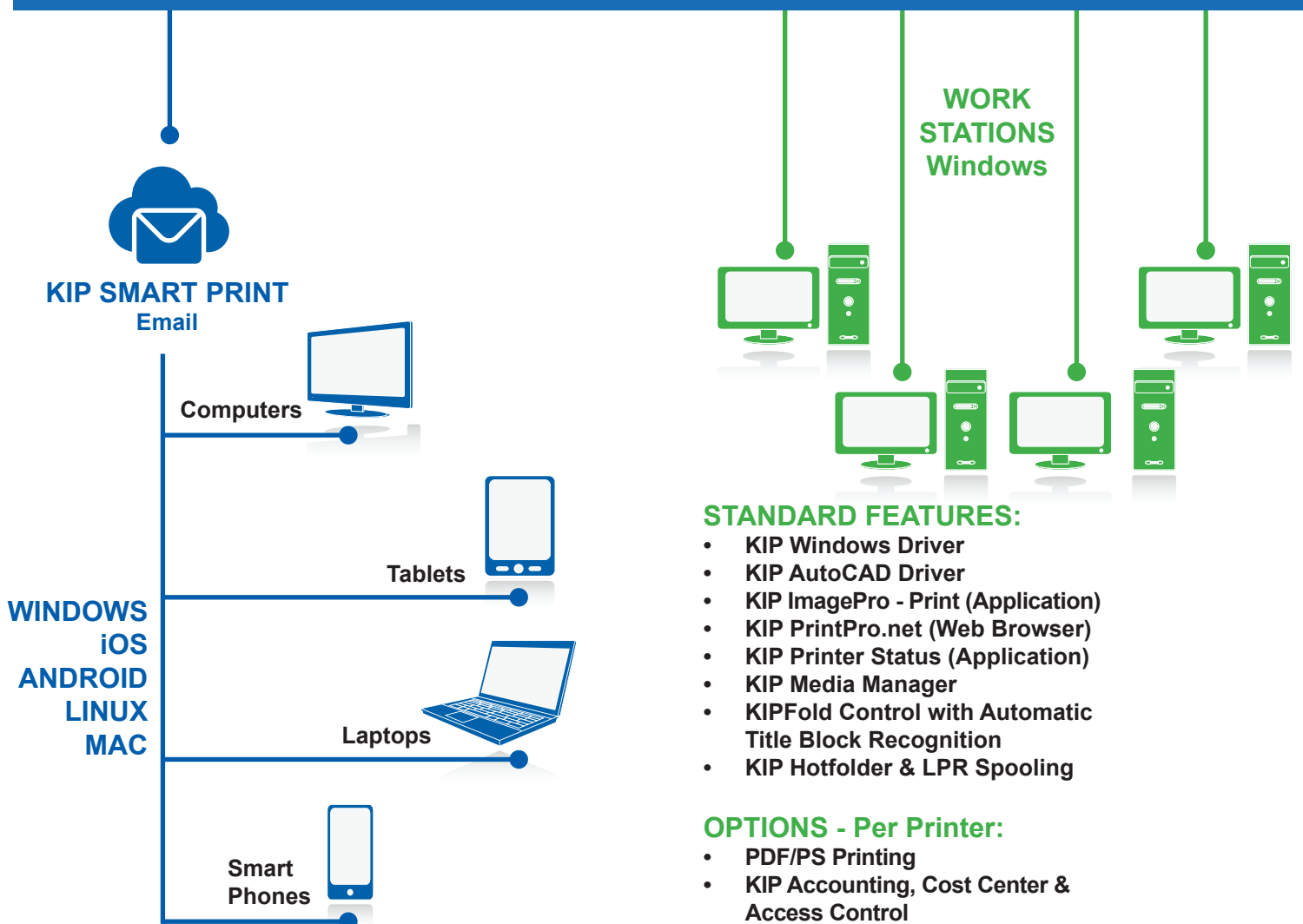

STANDARD FEATURES:

- KIP Windows Driver
- KIP AutoCAD Driver
- KIP ImagePro - Print (Application)
- KIP PrintPro.net (Web Browser)
- KIP Printer Status (Application)
- KIP Media Manager
- KIPFold Control with Automatic Title Block Recognition
- KIP Hotfolder & LPR Spooling

OPTIONS - Per Printer:

- PDF/PS Printing
- KIP Accounting, Cost Center & Access Control

KIP Color Series



**MFP
Printer**



**MFP
Printer**

KIP Scan Systems Scan, Copy & Print



- KIP ImagePro - Scan & Copy:**
- Scan - Local/USB/LAN/Cloud
 - Copy - To KIP Color or B&W printer
 - Print - To KIP Color or B&W printer
 - Color Adjustment / Management
 - High Definition Viewer
 - Area of Interest
 - KIPFold Control

WORK STATIONS

MAC

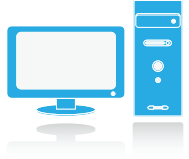

STANDARD FEATURES:

- KIP PrintPro.Net (Web Browser)
- PostScript Printer Description File
- KIP Hotfolder Support
- LPR Spooling

LINUX

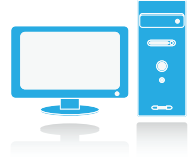

STANDARD FEATURES:

- KIP PrintPro.Net (Web Browser)
- KIP Hotfolder Support
- LPR Spooling

KIP DIGITAL DATA SECURITY



STANDARD FEATURES:

- Image Overwrite
- Removable Hard Disk Drive Accessory Kit
- Standard Security Updates
- KIP Secure Print
- KIP Accounting Center Integration

Comprehensive KIP System K features are available in the following brochures:

- KIP Multi-touch Solutions
- KIP PC & Web Print Solutions
- KIP Admin, Accounting & Access Control

KIP 900 Color Series Specifications

| | |
|---|---|
| 4 Roll Color and Black & White Printer | Color and black & white printer with intelligent KIP System K touchscreen |
| 4 Roll Color and Black & White Print/Copy/STF | Color and black & white printer with intelligent KIP System K touchscreen for Print/Copy and STF functions |
| System Scanners | KIP 980: KIP 720 CIS Scanner / KIP 990: KIP 2300 CCD Scanner |
| Scanner Stand | KIP 720 / KIP 2300 Scanner Stand (for the KIP 980-990 or optional for stand-alone scan applications) |
| Stacking Systems (standard) | KIP 900 Stacker |
| Finishing Systems (optional) | KIPFold 2800 |
| Description | High production color and black & white wide format print/copy/scan |
| Type | LED Array Electro photography with organic photoconductor (OPC drum) Contact Development using non magnetic mono-component toner |
| Configurations | Printer or multi-function system (print/copy/scan) |
| Speed | Up to 7,200 sq. ft (670 m ²) in single pass black or 5,760 sq. ft. (535 m ²) per hour in color regardless of image type or print resolution |
| Print Production | 20 D size prints per minute in black & white, 16 D size prints per minute in color |
| Warm Up Time | Instant from standby, less than 4 minutes from power on |
| Toner | Four color (CMYK), dry toner, print images are UV resistant and waterproof |
| Input Power | North America: 2x 208-240VAC +6%/-10% 50/60Hz, 16 A EU/UK: 2x 220-240 V, 50/60 Hz, 16 A |
| Power Consumption | Printing 2.4 kWh (Average), Ready 630 W (Average), Sleep Mode 3.4 W |
| Acoustic Noise | < 65 db (printing), < 60 db (standby) (ISO 7779) |
| Ozone | < 0.05 ppm (average of 8 hours) |
| Dimensions | KIP 970 60" x 43" x 48" / 1500 x 1080 x 1220 mm (W x D x H) KIP 980 78" x 43" x 48" / 1970 x 1080 x 1220 mm (W x D x H) KIP 990 78" x 43" x 48" / 1970 x 1080 x 1220 mm (W x D x H) |
| Weight | 1,212 lbs / 550 kgs NOTE: Weight of the optional scanner or stacker is not included |

Printer

| | |
|----------------------------------|--|
| Print Resolution | 600 x 1,800 dpi |
| Paper Capacity | 7,800 sq ft / 724 sq m (4 rolls + cut sheet) |
| Output Sizes Width (roll media) | 11" - 36" / 297 mm - 914 mm (3" Core) |
| Output Sizes Length (roll media) | 8.5" / 210 mm minimum, 210' / 64 m maximum (actual length may be dependent on media type and file type limitations) |
| Paper Weight (roll media) | See KIP Media Guide |
| Sheet Bypass | Up to 40 lbs. / 150 gsm bond Maximum sheet size 36" / 914 mm x manageable length Minimum sheet size 11" x 17" / A3 |
| Media Types | See KIP Media Guide |

Scanner / Copier

| | |
|------------|---|
| Resolution | 600 dpi (optical) |
| Original | Single Sheet, image viewable/face up |
| Widths | 8.5" - 36" / 210 mm - 914 mm (international standard page sizes to include ANSI, ARCH, ISO A & B, CHN, JPN) |
| Length | 8.5" - 19.7' / 210 mm - 6 m |

Please see the KIP 2300 Production CCD Scanner and KIP 720 CIS Convenience Scanner documentation for additional specification details.

Controller

| | |
|-------------------------|---|
| Controller Type | System K Embedded, Windows Standard Embedded 10 - 64 bit, i7 Quad Cord (min) |
| Memory | 16 GB (min) |
| Solid State Drive | Minimum 256 GB (Upgradable) |
| Compatible File Formats | Raster Color: TIFF, JPG, JPG2000, PNG, BMP, GIF, TGA, RLE/RLC Vector Color/B&W: HPGL, HPGL/2, HP-RTL, Postscript (PS/EPS), PDF, Autodesk DWF, Multipage PDF & DWF Raster B&W: TIFF Group 3 & 4, CALS Group 4, Grayscale TIFF Vector B&W: Calcomp 906/907 |

Space, Electrical & Environmental Requirements

| | |
|-------------------------|--|
| Total Space (minimum) | 132" x 182" / 3350 mm x 4610 mm (W x D) (KIP 900 Series with stacker) The flexibility of the KIP 980 / 990 system permits the scanner to be placed perpendicular or parallel to the KIP printer for individual workflows which can result in special requirements that may differ than noted above. |
| Electrical Requirements | KIP 970 = Dual 208 V - 240 V 50/60 Hz, 16 A KIP 980 / 990 = North America - the above, plus one 110 V - 120 V 50/60 Hz, 6 A or higher (for KIP scanner) EU & UK - three 220V - 240V 50/60 Hz 16A (for printer and scanner) |
| Electrical Receptacle | North America = two NEMA 6-20 R (plus one NEMA 5-20 R for the KIP 980 / 990) Europe = CEE 7 (x3 for KIP 980 / 990) UK = BS 546 (x3 for KIP 980 / 990) All other regions = please refer to your local standards |
| Network Port | RJ-45 port-CAT5 or higher. LAN rated at least at 100 mb. Recommended is 1000 mb |
| Room Temperature | 50-86 °F / 10-30 °C |
| Humidity | 15-80% RH |
| Site Survey | KIP 900 Series site survey documentation is to be completed prior to system installation |
| Min. Door Width | 32" / 813 mm |

KIP 900 Color Series Accessories

Stacker

The KIP 900 Color Series professional edge alignment stacker reduces post printing interaction, improving the efficiency and workflow. Neatly stacks a multitude of various page sizes. Unattended print runs can be scheduled with peace of mind.



KIPFold 2800

The KIPFold 2800 system automates wide format document folding requirements by providing folding, stacking and collation in a compact design. KIP online folders intelligently communicate with KIP printers and are fully integrated with KIP software applications & print drivers to provide seamless workflow integration.

Optional for KIP 970, 980, 990

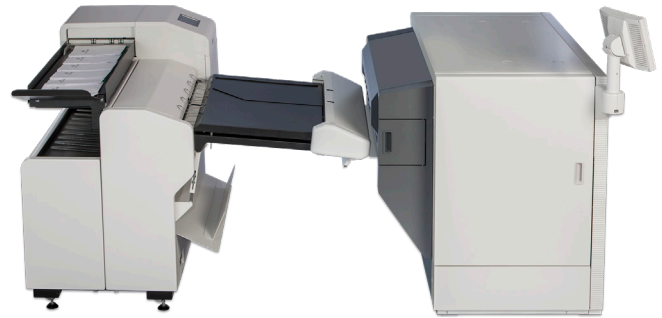

Copying & Scanning

The KIP 900 Color Series delivers efficient, high speed hard copy reproduction workflow. Exceptional image quality is achieved through true 600 x 600 dpi optical resolution via a choice of integrated KIP scanners, with advanced optics and delicate original transport processes for pixel-perfect images.

KIP 720 scanner included with KIP 980

KIP 2300 scanner included with KIP 990



THE COLOR OF KIP IS GREEN.

KIP is committed to product designs that promote environmental health and sustainability. KIP's goal is to consistently improve and refine the technologies in products that keep our planet green. KIP considers the total product life cycle - from the manufacturing process to final device disposal - in our shared ecosystems.



LOW EMISSIONS – HIGH EFFICIENCY

- KIP products all have a variety of sleep modes and power usage timers to reduce power consumption. All KIP systems are Energy Star qualified.
- During operation, the power consumption of KIP products are one of the lowest in the industry, thanks to efficiency in design.
- KIP's manufacturing processes have reduced electricity consumption by 33%, all while increasing productivity.



[KIP.COM/GREEN](https://www.kip.com/green) | FOR MORE INFORMATION

[WWW.KIP.COM](https://www.kip.com) | 800.252.6793