



Printers for Endless Possibilities

ComColor FW5231



High-speed inkjet printer

A3 / Ledger

120 ppm

FW 5231

Compact and feature-rich
to improve efficiency

Rethink inkjet.

Experience the difference with this ultra-fast compact printer that really delivers.



ComColor

The power of inkjet. Ultimate speed and efficiency.

Inkjet printers require no heat when printing unlike laser printers. ComColor FW5231 boasts ultra-fast print speed combined with a fast first print time to streamline printing, helping make busy work environments more efficient. Its ultimately low power consumption prevents paper from curling to reduce paper jams. And because output requires no cooling, pages can be sent immediately after printing to any of your optional finishers, vastly reducing production times.

Advancements all around

High productivity for any workplace.



With print speeds at 120 ppm, duplex scanning and a rich feature set, ComColor FW5231 brings a new level of productivity to any workplace. You'll also appreciate its modest footprint — the ideal choice where space is at a premium. Affordable on-demand, full-color printing ensures smooth operation to increase efficiency.

Superb efficiency for high volume printing.

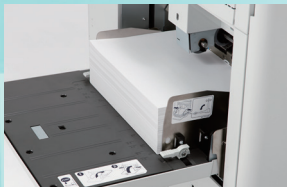

ComColor FW5231 is the right choice for low-cost color printing. Superb high-speed output combines with outstanding flexibility for cost-efficient in-house printing. It also goes easy on the environment thanks to the energy-saving design.

Excellent usability for every work environment.



The easy to use and intuitive user interface of ComColor FW5231 makes anyone a master of efficiency. Management and maintenance tasks are also simplified, ensuring speedy workflows and reduced downtime.

r FW5231

Superb efficiency for high volume printing.

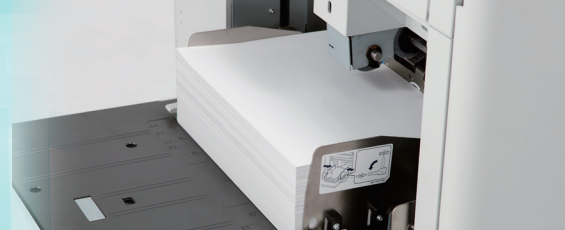

Low-cost color printing

ComColor Standard — RISO's original color profile — accurately controls the amount of ink ejected from the print head depending on document type and media. This maintains image quality and optimizes ink usage, ultimately lowering operating costs. Short print runs can now be performed inexpensively and efficiently in-house.

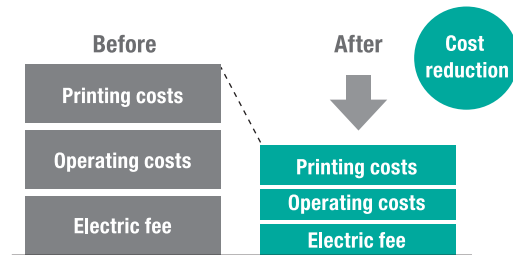

On-demand, full-color printing

White paper solution decreases waste, as it allows printing on-demand as and when required. ComColor FW5231 also supports variable-data printing, eliminating the need for pre-printed stock. Less outsourcing shortens turnaround time and lets you make last minute changes to documents.



Intelligent design for flexibility and efficiency

A simple paper-feed mechanism with no heating function supports a wide range of media, from plain paper and envelopes to cards. Paper is less likely to curl as no heat is applied during printing, thereby minimizing paper jams.

The energy-efficient printing process offers smooth, economical operation. Unlike toner-based printers, ComColor FW5231 employs an imaging process that eliminates ozone and toner emissions.



More energy-saving functions

Power schedule mode

This function allows you to automatically turn on and off the power of the machine at a specified time. Up to 10 sets of combinations of start or end time and day of the week can be registered. Never worry about forgetting to turn the printer off after working hours or over the weekend.

Sleep mode

Set when the printer enters sleep mode after the last print job to further decrease power consumption. This mode keeps power consumption to a miniscule 4W, further enhancing savings on electricity bills.

Save paper

Image Repeat and Combine

Combine multiple copies of the same page or multiple sheets onto a single printed page to save paper. This conveniently condenses bulky, multi-page documents into an easy-to-read format.

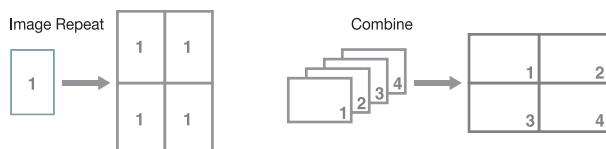

Blank Page Detection

Also, when required you can automatically omit blank pages in documents, saving both time and paper to further reduce running costs.



Note: This function is only available when using the printer driver. Pages with a header/footer will not be recognized as blank even if there is no page data.

Excellent usability for every work environment.



Designed for simple operation

An easy-to-view touch panel with instantly recognizable color icons makes printer operation simple for anyone. The tilt panel ensures excellent viewing at any angle up to 90 degrees, expanding installation flexibility. Scan preview windows show scanned images before saving data, ensuring less scan failures. For added convenience when printing and copying, frequently used functions can be saved as Favorites.



Expanded usability

The optional PS kit supports a variety of operating systems, and PDF files can be printed directly from USB flash drives, while RISO Print-S application allows printing from smart devices. ComColor FW5231 offers reliable support for any work environment.



ComColor functions and output modes

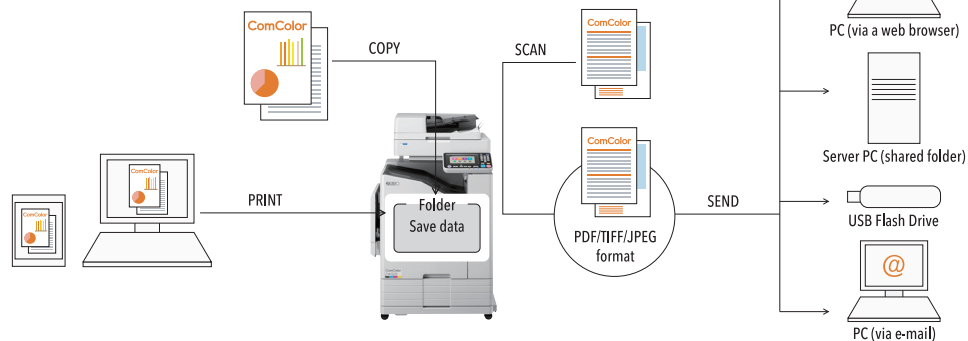

Useful scanner functions

The optional Scanner HS7000 can save scanned data over the network to a PC, as an attachment to e-mail, or onto a hard disk of a networked RISO machine. Multi-page documents can be saved in PDF format as either separate files or combined into one file. Documents can be saved as PDF, TIFF, JPEG and PDF/A (suitable for long-term storage) formats.



Easy management for administrators

Up to 1,000 users can be registered. Connecting to an internal directory with LDAP authentication ensures quick configuration for a large number of users. The optional IC Card Authentication Kit enable user management using an IC card. Other maintenance tasks can be performed simply and speedily.



Optional accessories to customize your workflow

Face Down Finisher F10

Compact finisher exclusively for offset stacking and stapling finished prints.

Applicable Paper Size

Without offset
Maximum: 340 mm x 550 mm (13 3/8" x 21 5/8")
Minimum: 90 mm x 148 mm (3 9/16" x 5 27/32")

Offset output
Regular sized paper width: 182 mm x 257 mm - 297 mm x 431.8 mm (7 3/16" x 10 1/8" - 11 11/16" x 17")
Irregular sized paper width: 131 mm x 148 mm - 305 mm x 550 mm (5 3/16" x 5 27/32" - 12" x 21 5/8")

Paper Weight 46 gsm to 210 gsm (12-lb bond to 56-lb bond)

Tray Capacity Height up to 108 mm (4 1/4")

Maximum Number of Sheets for Staples

50 sheets* A4, B5 (JIS), Letter

25 sheets* A3, B4 (JIS), Ledger, Legal, Foolscap

Paper Weight for Staple 52 gsm to 210 gsm (14-lb bond to 56-lb bond)

Staple Position

1 at front side (angle stapling)

1 at rear side (angle stapling)

2 at center (parallel stapling)

Power Consumption Max. 100 W

Print Speed (long-edge feed, simplex)

Without offset 120 ppm

Offset output 105 ppm

* When using plain paper or recycled paper (85 gsm (23-lb bond))

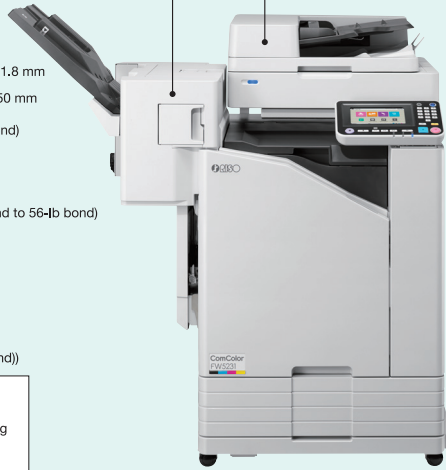
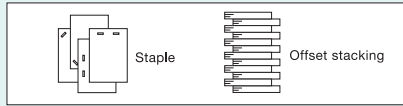

Scanner HS7000

The auto feeder enables copying and scanning of duplex originals of up to 200 sheets*1 at a time.

Copy Functions

Writing Resolution
Standard: 300 dpi x 300 dpi
Fine: 300 dpi x 600 dpi

Copy Paper Size
Maximum: 303 mm x 432 mm (11 15/16" x 17")
Monochrome/Color: 7 sec or less*2

Copying Speed 70 ppm (Simplex/Duplex)*3

Scan Functions

Scanning Speed Monochrome/Color: 100 ppm*4

Network Interface Ethernet 1000BASE-T/100BASE-TX/10BASE-T

Data-saving Format Monochrome: TIFF, PDF
Grayscale/Full Color: TIFF, JPEG, PDF

Power Consumption Max. 100 W

*1 80 gsm (21-lb bond) or less

*2 When copying A4/Letter long-edge feed, using Color Priority Mode

*3 When copying A4/Letter long-edge feed, using Auto Document Feeder

*4 RISO KAGAKU standard original, A4/Letter long-edge feed, 300 dpi, JPEG or PDF, when stored to main unit hard drive, using Auto Document Feeder

Multifunction Finisher FG10

Intelligent inline functions performed automatically simplify the finishing process.

Stapling Stapling options include: One corner staple or two staples for up to 100 sheets* of paper.

Punching Holes can be punched through documents. Choose two/three holes in the U.S., or two/four holes elsewhere.

Folding Various automatic folding options are available [inward; outward; for A3/ledger-to-A4/Letter sheet footprint reductions; and two-fold for up to five sheets making a 20-page booklet].

Booklet making Automatic saddle stitch stapling of up to 60 pages (15 sheets).

* When using plain paper or recycled paper (85 gsm (23-lb bond)) for A4, Letter, and B5



Folder Unit FG10

Folder Unit FG10 supports A4 tri-fold and A3 Z-fold*1.

*1 Does not support tri-fold or Z-fold for multi-page documents.

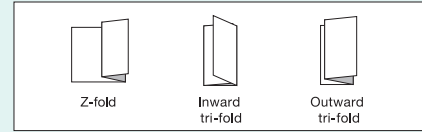
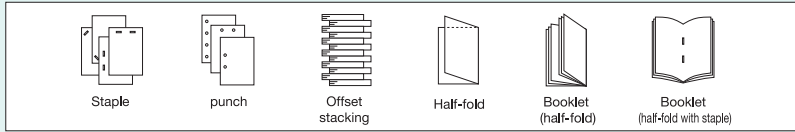

RISO Auto-Control Stacking Tray II

The paper guides automatically open to the correct width to match the paper in use.

Paper Size

Maximum: 320 mm x 432 mm (12 9/16" x 17")

Minimum: 90 mm x 148 mm (3 15/16" x 5 13/16")

Tray Capacity* 1,000 sheets

* When using plain paper or recycled paper (85 gsm (23-lb bond))



Wide Stacking Tray

Paper Size

Maximum: 340 mm x 550 mm (13 3/8" x 21 5/8")

Minimum: 90 mm x 148 mm (3 9/16" x 5 13/16")

Tray Capacity* 1,000 sheets

* When using plain paper or recycled paper

(85 gsm (23-lb bond))



PS Kit FG10

When the PS Kit is installed, several functions useful for more efficient use — such as Tray Selection Per Page, Color Profile, Form Overlay — are available.

PDL* PostScript Level3 (CPSI:3019), PCL 6 (PCL XL, PCL 5c)

Installed Fonts PS: 136 Roman fonts PCL: 88 Roman fonts

* Page Description Language

IC Card Authentication Kit II

The optional IC Card Authentication Kit enables user management using an IC card.

Consumables

ComColor FW Ink Cartridges

Replenishing ink is clean and easy with slim ink cartridges and the ComColor's clever design.

Colors: Black Cyan Magenta Yellow



HC Staple 100

Staples for the Multifunctional Finisher FG10.
Unit: 15,000 pieces of staples per carton box.



HC Staple Booklet

Saddle stitch staples for the Multifunctional Finisher FG10. Unit: 20,000 pieces of staples per carton box.



ComColor Staple 50(G)

Staples for the Face Down Finisher F10.
Unit: 15,000 pieces of staples per carton box.



Dimensions

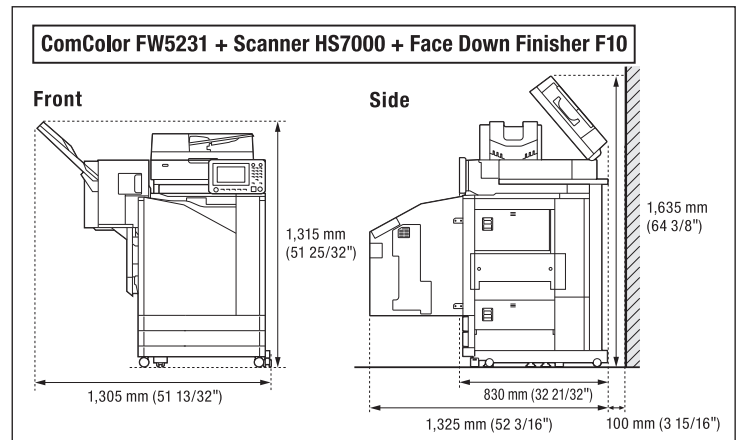

ComColor FW5231

Specifications

Print Type	Line-type inkjet system	
Ink Type	Oil-based pigment ink (Cyan, Magenta, Yellow, Black)	
Print Resolution	Standard: 300 dpi (main scanning direction) × 300 dpi (sub-scanning direction) Fine: 300 dpi (main scanning direction) × 600 dpi (sub-scanning direction)	
Number of Gray Levels	For each CMYK color (11 gray levels)	
Data Processing Resolution	Standard: 300 dpi × 300 dpi Fine: 600 dpi × 600 dpi Line smoothing: 600 dpi × 600 dpi	
Warm-up Time	2 min. 30 sec. or less (at room temperature of 23°C (73.4°F))	
First Print Time*1	5 sec. or less (A4 long-edge feed)	
First Copy Time*1	7 sec. or less (A4 long-edge feed)	
Continuous Print Speed*2*3	A4 long-edge feed	Simplex: 120 ppm Duplex: 60 sheets/minute (120 ppm)
	Letter long-edge feed	Simplex: 120 ppm Duplex: 60 sheets/minute (120 ppm)
	A4 short-edge feed	Simplex: 90 ppm Duplex: 45 sheets/minute (90 ppm)
	Letter short-edge feed	Simplex: 90 ppm Duplex: 45 sheets/minute (90 ppm)
	B4 (JIS) short-edge feed	Simplex: 76 ppm Duplex: 34 sheets/minute (68 ppm)
	Legal short-edge feed	Simplex: 76 ppm Duplex: 34 sheets/minute (68 ppm)
	A3 short-edge feed	Simplex: 66 ppm Duplex: 32 sheets/minute (64 ppm)
Paper Size	Standard Tray	Maximum: 340 mm × 550 mm (13 3/8" × 21 5/8") Minimum: 90 mm × 148 mm (3 9/16" × 5 27/32")
	Printable Area	Maximum: 310 mm × 544 mm (12 3/16" × 21 13/32")
Guaranteed Print Area*4	Standard: Margin width of 5 mm (7/32") Maximum: Margin width of 3 mm (1/8")	
Paper Weight	Standard Tray	Simplex: 46 gsm to 210 gsm (12-lb bond to 56-lb bond) Duplex: 46 gsm to 210 gsm (12-lb bond to 56-lb bond) for A4 and Letter 46 gsm to 104 gsm (12-lb bond to 28-lb bond) for Ledger, A3, Legal, and B4
Paper Tray Capacity	Standard Tray	Height up to 110 mm (4 5/16")
Output Tray Capacity	Height up to 56 mm (2 3/16")	
PDL (Page Description Language)	RISORINC/C IV	
Supported Protocols	TCP/IP, HTTP, HTTPS, DHCP, ftp, lpr, IPP, SNMP, Port 9100 (RAW port), IPv4, IPv6, IPsec	
Supported Operating Systems	Standard	Microsoft®: Windows Vista® (32-bit/64-bit), Windows® 7 (32-bit/64-bit), Windows® 8.1 (32-bit/64-bit), Windows® 10 (32-bit/64-bit), Windows Server® 2008 (32-bit/64-bit), Windows Server® 2008 R2 (64-bit), Windows Server® 2012 (64-bit)
	Optional*5	Mac®: OS X 10.8 (64-bit), 10.9 (64-bit), 10.10 (64-bit), 10.11 (64-bit) Linux (compatible with PPD only)
Network Interface	Ethernet 1000BASE-T, 100BASE-TX, 10BASE-T	
Memory Capacity	4 GB	
Hard Disk*6	Capacity	500 GB
	Available Space	Approx. 430 GB
Operating System	Linux	
Power Source	AC 100-240 V, 10.0-5.0 A, 50-60 Hz	
Power Consumption	Max. 1,000W	
	Ready*7: 150 W or less	
	Sleep*8: 4 W or less	
	Stand-by: 0.5 W or less	
Operating Noise	Max. 65 dB (A) A4 long-edge feed (Simplex) at the maximum print speed	
Operating Environment	Temperature: 15°C to 30°C (59°F to 86°F) Humidity: 40% to 70% RH (non-condensing)	
Dimensions (W × D × H)	In use: 1,030 mm × 725 mm × 1,115 mm (40 19/32" × 28 9/16" × 43 29/32") With cover and tray closed: 775 mm × 705 mm × 970 mm (30 17/32" × 27 25/32" × 38 7/32")	
Weight	Approx. 130 kg (286 lb)	
Safety Information	IEC60950-1 compliant, Indoor, pollution degree 2*9, At altitudes of 2,000 m or lower	
Required Space (W × D × H)*10	1,305 mm × 1,215 mm × 1,115 mm (51 13/32" × 47 27/32" × 43 29/32")	

Specifications are subject to change without notice.

*1 Within 10 minutes after the last print job *2 When using plain paper (85 gsm (23-lb bond)), and density setting 3 (Standard) Chart used: Print measurement pattern [Color measurement sample 2 (JEITA standard pattern J6)] *3 The continuous print speed varies depending on the type of optional output equipment connected. *4 The margin when printing envelopes is 10 mm (3/8"). The guaranteed area when printing images is the area enclosed within 5 mm (7/32") of the edges of the paper. *5 Optional PS kit is required. *6 One gigabyte (GB) is calculated as 1 billion bytes. *7 Without printing and temperature adjustment operation *8 When setting [Power Consumption (in sleep)] to [Low]. *9 The pollution degree of the usage environment due to dirt and dust in the air. Degree "2" corresponds to a general indoor environment. *10 With the front cover open and the operation panel in the upright position.

© RISO, ComColor, and FORCEJET are trademarks or registered trademarks of RISO KAGAKU CORPORATION. Adobe and PostScript are either registered trademarks or trademarks of Adobe Systems Incorporated in the United States and/or other countries. Mac is a trademark of Apple Inc. Microsoft, Windows, Windows Server and Windows Vista are either registered trademarks or trademarks of Microsoft Corporation in the United States and/or other countries. Other corporate names and/or trademarks are either registered trademarks or trademarks of each company, respectively.



RISO, Inc.
800 District Ave, Suite 390 Burlington, MA 01803
http://us.riso.com

For more details please contact: