



ComColor 3150

*Speed up your color communications
to boost up your business*



A4/Letter

90 ppm

Multiple Paper Trays

Enhance workflow efficiency Streamline print production

The RISO ComColor combines powerful, high-speed performance with low running costs, increased productivity and reliability, for superior performance.



ComColor 3150

Productive • Efficient • Reliable • Eco-friendly

Quick, reliable, and easy

The RISO ComColor 3150 provides full-color high-speed printing of 90 ppm*1 and startup takes a mere 5 seconds*2. This convenient model is an ideal fit for your high-volume printing jobs.

Time to print 1,000 full-color A4/letter simplex pages



Productive and versatile features achieve optimum results



Flexible paper feeding

Maximize paper capacity for high-speed printing by utilizing multiple paper trays. Paper feeds horizontally beneath the print heads in a short straight path, contributing to high print speeds and increased reliability.

Improved paper handling

Improved

Unique capabilities broaden the range of paper stocks and sizes that can be reliably printed at high speeds. The wide variety of paper stocks includes envelopes and lightweight paper.

Designed for longevity

The ComColor, engineered for high-production environments, is built to last. Proven durability guarantees millions of prints.

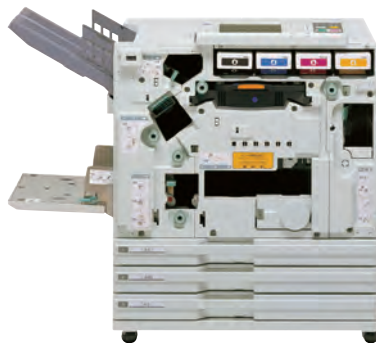

ENGINE TECHNOLOGY FORCEJET™



RISO technology drives high-speed, large-volume printers to new heights

In-line inkjet print heads

Four wide in-line inkjet heads arranged in parallel allow very speedy full-color printing at a single pass. Eight-step control per ink drop per color dot assures excellent results with fine tonal gradations.

Special fast-drying ink

To suit the ultra high-speed duplex printing capabilities of the ComColor, RISO developed special fast-drying, fade-resistant, water-resistant oil-based inks that prevent set-off and paper curl.

Stable paper feeds

A reliable paper-feeding mechanism paves the way for high-speed printing with minimal print offset. Paper-feeding speed is intelligently controlled according to how much ink sprays from the print head. Also, multiple sensors help to keep paper jams and other problems to a minimum.

*1 A4 short-edge feed, simplex, continuous printing, plain paper (85 gsm (23-lb bond)) in standard mode (print density setting 3). Chart used: Print measurement pattern [Color measurement sample Z (JEITA standard pattern J6)].

*2 Within 10 minutes after the last print job.

Increase Capabilities

Productivity-enhancing accessories automate workflow from start to finish. Take control of print jobs with flexible options. High-capacity feeding and stacking, and various finishing functions streamline production and eliminate the need for outsourcing.



Continuous high-capacity printing

High Capacity Feeder

NEW

Maximize high-speed printing benefits with this option that enables uninterrupted, unattended, high-volume print runs without pausing to reload paper.

- Maximum stacking height: 440 mm (17 5/16")
- Paper weight: 46 gsm to 210 gsm (12-lb bond to 56-lb bond)
- Paper size: 90 mm x 148 mm to 340 mm x 460 mm (3 9/16" x 5 13/16" to 13 3/8" x 18 1/8")



High Capacity Stacker

NEW

This option allows stacking of larger output volumes, reducing user intervention. Stacker cart neatly and easily transports finished prints.

- Maximum stacking height: 440 mm (17 5/16")
- Paper weight: 46 gsm to 210 gsm (12-lb bond to 56-lb bond)
- Paper size: Without offset: 90 mm x 148 mm to 340 mm x 460 mm (3 9/16" x 5 13/16" to 13 3/8" x 18 1/8") With offset: 90 mm x 182 mm to 340 mm x 432 mm (3 9/16" x 7 3/16" to 13 3/8" x 17")
- Automatic paper guide control
- Offset stacking
- High speed switchback unit



Four versatile main functions: stapling, punching, folding and binding

Multifunction Finisher II

Improved

Intelligent inline functions performed automatically simplify the finishing process.

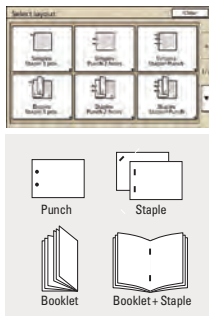

• Applicable functions may differ according to the printer model.

• Stapling

Stapling options include: One corner staple or two staples for up to 100 sheets* of paper.

• Punching

Holes can be punched through documents.

• Folding

Various automatic folding options are available [inward; outward; A4/letter sheet footprint reductions; and two-fold for up to five sheets making a 20-page booklet].

• Booklet making

Automatic saddle stitch stapling of up to 60 pages (15 sheets).

* When using plain paper and recycled paper (85 gsm (23-lb bond))

Face Down Offset Stapler

NEW

Compact option exclusively for offset stacking and stapling finished prints. Stapling options include: One corner staple or two staples for up to 50 sheets*1.

- Paper size: Without offset: 90 mm x 148 mm to 340 mm x 550 mm (3 9/16" x 5 13/16" to 13 3/8" x 21 5/8")
- Maximum stacking height: Up to 108 mm (4 1/4")*2
- Output speed: Normal: 90 ppm*3
- Stapling: 42 ppm*3 (simplex/duplex)

*1 When using plain paper and recycled paper (85 gsm (23-lb bond))

*2 When using A4, Letter, Foolscap

*3 When using the ComColor 3150, short-edge feed, simplex



Standard sorting and grouping by quantity

Collate function

Use the collate function to group output either by sort for printing and sorting a desired number of copies in page order. Or by group for printing and sorting the copies by page group.



Slip sheet

Insert slip sheets between prints at desired quantity intervals. This feature can be used for inserting a cover page on each copy printed in a batch, for example.

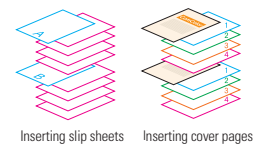

Program print

Set specific print quantities for each group, up to 60 groups.



Reduce Running Costs

To minimize ink consumption and maintain optimal print quality, RISO's standard color profile intelligently controls the quantity of ink drops used for each individual color, according to the paper type, to effectively reproduce the original image.

Save even more ink

Auto color mode

For documents that include monochrome and color pages, the auto color mode can reduce costs by automatically detecting the presence or absence of color, which minimizes ink in consumption.

Single color printing

Print using one color (black, cyan or magenta) for a colorful effect with reduced ink consumption.

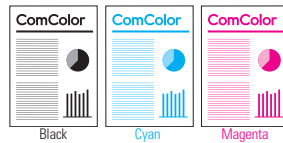

Save paper, too

Multi-up printing

Combine multiple copies of the same page, or copies of multiple pages onto a single printed page to save paper. Conveniently condense bulky multiple page documents in an easy-to-read format.



Blank page removal

Automatically omits blank pages in documents saving both time and paper, and further reduces running costs.



- This function is only available when using printer driver.
- In cases without data, header/footer included pages will not be recognized as blank pages.

Eco-friendlier Than Ever

The new RISO ComColor reduces power consumption to an all-time low with the introduction of automatic power shut-off. The ComColor is ENERGY STAR certified* and boasts many other energy-efficient innovations. The ComColor technology is truly green.

* In limited regions.



Improved

Lower power consumption

Now, standby and sleep modes consume even less power than previous models. Power consumption when printing is just 0.15 Wh per sheet.

Standby power consumption

Previous model Less than **250 W**

ComColor 3150 Less than **150 W**

Sleep mode power consumption

Previous model Less than **45 W**

ComColor 3150 Less than **5 W**

Power consumption per sheet

Previous model Approx. **0.22 Wh**

ComColor 3150 Approx. **0.15 Wh**

NEW

Power schedule function

This new function is a convenient energy saver. Automatically set the printer's system power ON and OFF at desired times. Schedule times to power ON so the printer is ready when necessary, and power OFF when it is not required.

Improved

Noise reduction

The new ComColor runs quieter than previous models. Operational noise is reduced by implementing nine distinct noise-reduction improvements. This "quiet design" suppresses both running and standby noise, providing a comfortable printing environment.



Superior Simplicity and Quality

With improved performance and functions, the ComColor consistently delivers quality prints with convenience and simplicity for every user.

Easy operation and ink replenishment

Color LCD touch screen

Functions for printing, copying, scanning and managing data are at your fingertips logically arranged for intuitive operation on a large LCD touch screen.



Easy-to-change ink cartridges

Replenishing ink is clean and easy with slim ink cartridges and the ComColor's clever design.



Efficient data processing

Scanner HS5000

Improved

The auto feeder enables scanning of double-sided originals of up to 100 sheets* of paper at a time. Documents can quickly and easily be copied, scanned or stored in PDF, TIFF, and JPEG formats.

- Scanning speed
Simplex: 50 ppm
Duplex: 24 ppm
- Initial copy time: less than 7 seconds
- Maximum scanning area
Flat Bed: 303 mm x 432 mm (11 15/16" x 17")
Auto-Document Feeder: 295 mm x 430 mm (11 5/8" x 16 15/16")
- Scanning resolution: 600 dpi
- Output resolution
Standard: 300 dpi x 300 dpi
Fine: 300 dpi x 600 dpi

* Paper smaller than B4, 80 gsm or less



ComColorExpress IS1000C

Improved

Various functions are available, such as form printing (for combining data to a saved form), header/footer function (for adding page numbers or text), merge function (for combining various saved data into one unit) and tray select function (for selecting trays per page).

Advanced Adobe® PostScript® 3™ controller handles complex high-volume variable data and graphic-intensive jobs.

CPU: Intel® Xeon® E3-1275 3.4GHz
Memory: 8 GB
HDD: 500 GB

• ComColorExpress IS1000C or IS950C required for Mac compatibility.



Direct printing from a USB flash drive

NEW

For direct printing even when the machine is not connected to a network, simply insert a USB flash drive containing the data into the machine's USB slot. Direct printing not only saves time — the image quality is improved over scanned originals.

• The data for direct printing needed to be RISO original format (PRN format).



ComColorExpress IS950C

Improved

Basic Adobe® PostScript® 3™ option.

CPU: Intel® Pentium® G850 2.9GHz
Memory: 2 GB
HDD: 500 GB

• ComColorExpress IS1000C or IS950C required for Mac compatibility.

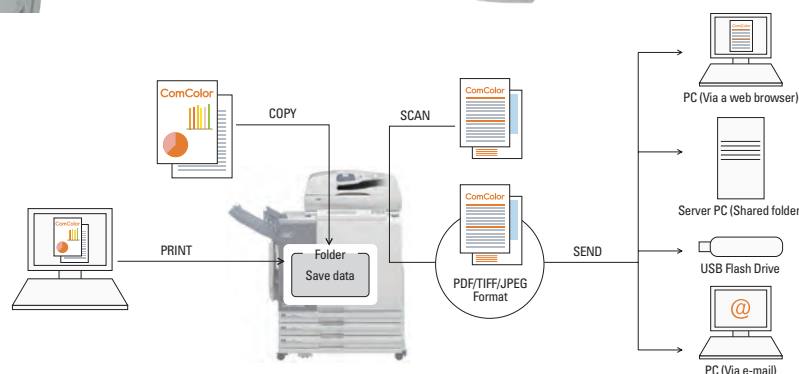



Impressive image quality on standard paper and envelopes

Advanced ink formulation for higher quality output

Improved

Newly developed ink technology, ComColor X1, reduces ink see-through and improves black ink density.

Improved envelope printing quality

Improved

Envelope printing is improved with an enhanced paper feeding mechanism for reliable envelope handling, and a new image-processing printer driver function for enhanced image quality.

Various functions optimize output

• Mixed-size printing

When printing originals of mixed sizes into a single document, the size of each original is automatically detected for printing on appropriately sized paper.

• Photo and line mode

Choose from two print modes to enhance quality. Select photo mode for printing photographs with natural tones. Select line mode to make text and lines of illustrations look clearer.

• Line smoothing

Line smoothing helps reduce or eliminate unsightly jagged edges that tend to appear, particularly in large fonts and illustrations.



Line smoothing OFF



Line smoothing ON

Secure print

PIN code enhances security

Confidential documents need to be kept away from prying eyes — even when they are being printed. PIN code security lets you simply specify a PIN code when sending confidential jobs to the ComColor. When the job is ready to be printed, enter the PIN code on the ComColor control panel to release the job. The job cannot be viewed or printed without authentication.

Dimensions

ComColor Main Unit

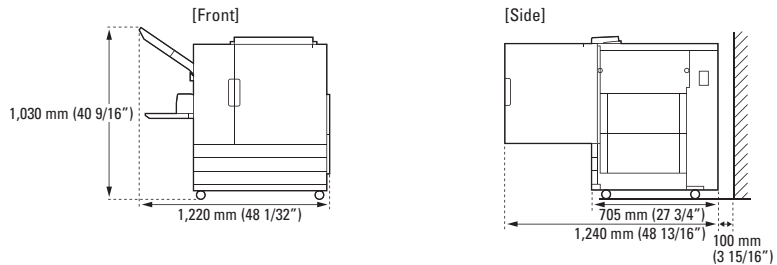

ComColor + Scanner HS5000 + Multifunction Finisher II

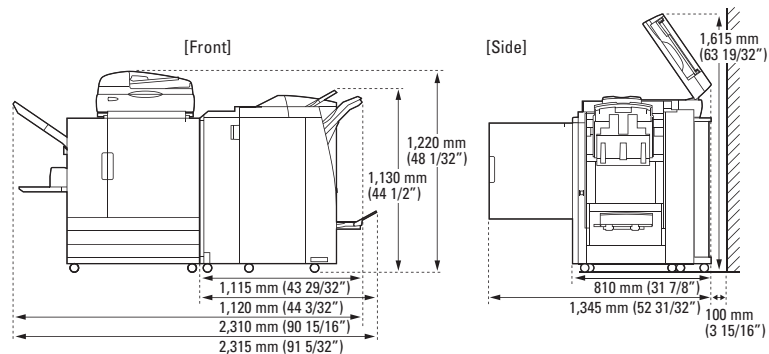

ComColor 3150

Specifications

Print Type	Line-type inkjet system	
Ink Type	Oil-based pigment ink (Cyan, Magenta, Yellow, Black)	
Resolution	Standard: 300 dpi (main scanning direction) × 300 dpi (subscanning direction) Fine: 300 dpi (main scanning direction) × 600 dpi (subscanning direction)	
Number of Gray Levels	For each CMYK color (8 gray levels)	
Data Processing Resolution	Standard: 300 dpi × 300 dpi Fine: 300 dpi × 600 dpi Line smoothing: 600 dpi × 600 dpi	
Warm-up Time	2 min. 45 sec. or less (at room temperature of 20°C (68°F))	
First Print Time	5 sec. or less*1 (when copying A4/Letter short-edge feed using color mode)	
Continuous Print Speed ^{*2,6}	A4 short-edge feed	Simplex: 90 ppm, Duplex: 45 sheets/minute (90 ppm)
	Letter short-edge feed	Simplex: 90 ppm, Duplex: 45 sheets/minute (90 ppm)
	Legal short-edge feed	Simplex: 76 ppm, Duplex: 38 sheets/minute (76 ppm)
Paper Size	Standard Tray	Maximum: 340 mm × 550 mm (13 3/8" × 21 5/8") Minimum: 90 mm × 148 mm (3 9/16" × 5 13/16")
	Feed Tray	Maximum: 297 mm × 420 mm (11 11/16" × 17") Minimum: 182 mm × 182 mm (7 3/16" × 7 3/16")
Printable Area	Maximum: 210 mm × 544 mm (8 1/4" × 21 7/16")	
Guaranteed Print Area ^{*3}	Standard: Margin width of 5 mm (3/16") Maximum: Margin width of 3 mm (1/8")	
Paper Weight	Standard Tray	46 gsm (12-lb bond) to 210 gsm (56-lb bond) (plain paper)
	Feed Tray	52 gsm (14-lb bond) to 104 gsm (28-lb bond) (plain paper)
Paper Feed Method/ Paper Tray Capacity	Standard Tray	Height up to 110 mm (4 5/16")
	Feed Tray	Height up to 50 mm (1 15/16") (× 3 trays)
Output Tray Capacity	Standard	Height up to 60 mm (2 3/8")
Page Description Language	RISORINC/CIII	
Supported Protocols	TCP/IP, HTTP, HTTPS (SSL), DHCP, ftp, lpr, IPP, SNMP, Port 9100 (RAW port), IPv4, IPv6, IPsec	
Supported Operating Systems	Microsoft® Windows® XP (32-bit), Microsoft® Windows Server® 2003 (32-bit/64-bit), Microsoft® Windows Server® 2003 R2 (32-bit/64-bit), Microsoft® Windows Vista® (32-bit/64-bit), Microsoft® Windows Server® 2008 (32-bit/64-bit), Microsoft® Windows Server® 2008 R2 (64-bit), Microsoft® Windows® 7 (32-bit/64-bit), Microsoft® Windows® 8 (32-bit/64-bit) ^{*8} , Microsoft® Windows Server® 2012 (64-bit) ^{*8}	
Network Interface	Ethernet 1000BASE-T, 100BASE-TX, 10BASE-T	
Memory Capacity	1 GB	
Hard Disk ^{*4}	Capacity	320 GB
	Available Space	280 GB
Operating System	Linux	
Power Source	AC 100-240 V, 10-5 A, 50-60 Hz	
Power Consumption	Maximum: 1,000 W Ready ^{*5} : 150 W or less Sleep ^{*7} : 5 W or less Stand-by: 0.5 W or less	
Operating Noise	Max. 66 dB (when printing without optional equipment connected)	
Operating Environment	Temperature: 15°C to 30°C (59°F to 86°F) Humidity: 40% to 70% RH (non-condensing)	
Dimensions (W × D × H)	In use: 1,220 mm × 705 mm × 1,030 mm (48 1/32" × 27 3/4" × 40 9/16") Cover and feed trays closed: 1,155 mm × 705 mm × 1,010 mm (45 15/32" × 27 3/4" × 39 3/4")	
Required Space (W × D × H)	Cover and feed trays opened: 1,220 mm × 1,240 mm × 1,030 mm (48 1/32" × 48 13/16" × 40 9/16")	
Weight	Approx. 171 kg (376 lb)	

Specifications are subject to change without notice.

*1 Within 10 minutes after the last print job

*2 When using plain paper and recycled paper (85 gsm (23-lb bond)), and density setting 3 (Standard) Chart used: Print measurement pattern [Color measurement sample 2 (JEITA standard pattern J6)]

*3 The margin when printing envelopes is 10 mm (3/8"). The guaranteed area when printing images is the area enclosed within 3 mm (1/8") of the edges of the paper.

*4 One gigabyte (GB) is calculated as one billion bytes.

*5 Without printing and temperature adjustment operation

*6 The continuous print speed varies depending on the type of optional output equipment connected. Multifunction finisher: Max. 90 sheets/minute (A4 short-edge feed simplex) Face down offset stapler: ComColor 3150: Max. 90 sheets/minute (A4 short-edge feed simplex)

*7 When setting [Power consumption (in sleep)] to [Low].

*8 Will soon be compatible, however will remain incompatible with Microsoft® Windows® RT.

RISO logo, ComColor, ComColorExpress, and FORCEJET are trademarks or registered trademarks of Riso Kagaku Corporation. Adobe and PostScript are either registered trademarks or trademarks of Adobe Systems Incorporated in the United States and/or other countries. Mac is a trademark of Apple Inc. Microsoft, Windows, Windows Server and Windows Vista are either registered trademarks or trademarks of Microsoft Corporation in the United States and/or other countries. Intel, Pentium and Xeon are trademarks of Intel Corporation in the United States and/or other countries. Other corporate names and/or trademarks are either registered trademarks or trademarks of each company, respectively.



RISO KAGAKU CORPORATION
5-34-7 Shiba, Minato-ku, Tokyo 108-8385 Japan
<http://www.riso.com>

For more details please contact: