

SHARP

Be Original.

MX-B450W MX-B350W

Digital Multifunction System



**Low-Friction Workflow
with Wireless Connectivity**



New Dimensions of Flexible Document Productivity

The MX-B450W/B350W is a compact and versatile B&W document solution that adds real value to any workplace. Whether in a large or small office, it offers space-efficient productivity and 4-in-1 functionality. Its built-in wireless LAN connectivity brings office-wide convenience and the ability to join a network of A3/A4 MFDs. With its small footprint* of 428 × 507 mm, the MX-B450W/B350W fits easily on a desk or under a counter. Wherever you place it, you'll enjoy solid performance and a smooth workflow.

* "Footprint" refers to the part directly adjacent to the floor or desk space. The numerical value is for the MFD's base unit only.



WIRELESS CAPABILITY

Wireless Connections

This MFD offers ultra-handy wireless access via two easy modes, enabling convenient access to the MFD even from places where it's difficult to connect a LAN cable.

Infrastructure mode



Wireless LAN router

Infrastructure mode wirelessly connects the MFD to a wireless LAN router connected to the intranet.

Access point mode



Access Point mode* wirelessly connects a LAN-wired MFD to mobile PCs/devices without going through a wireless LAN router.

* External networks cannot be accessed via the MFD. Up to five mobile devices can be wirelessly connected to the MFD at the same time.

USABILITY

Direct Printing/Scanning with USB Drives

Insert a USB drive into the MFD and a command screen automatically pops up on the LCD. Right away you can print files from the USB drive or scan documents directly to the USB drive.



Device Management

Sharp Remote Device Manager* (SRDM) gives administrators centralised control of their networked MFDs and printers. This software covers system setup, security settings, troubleshooting, and more.

* Contact a Sharp customer representative for availability and other details.

Reliable Security

- **User authentication** prevents unauthorised use of the MFD. Up to 30 users can register a unique access number
- Retained data can be **erased** when it's time to replace the MFD, to prevent confidential information from leaking

Sharpdesk Mobile

Sharpdesk Mobile is a mobile print/scan application. With Sharpdesk Mobile, users can import documents scanned on the MFD to their mobile devices for previewing and saving. And files on a mobile device can be printed out on the MFD, sent as e-mail attachments, or used in other applications.

Easy-to-Use Control Panel

The MFD has a user-friendly control panel. Next to it are two LED lamps: one red, one green. These light up to notify you—even from a distance—of the status of the machine.

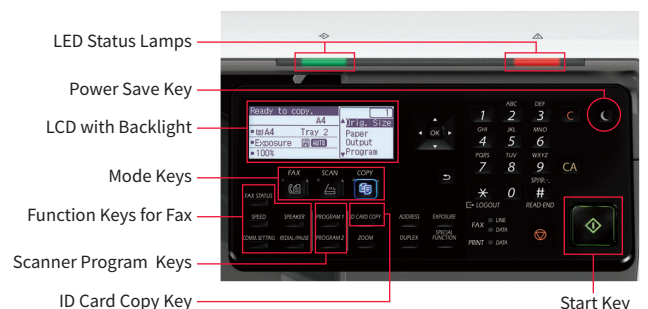

COPY/PRINT

Efficient Output

This MFD delivers a fast output of 45/35 ppm*. The first copy comes out in 8.5/9.0 seconds, saving you valuable time when performing multiple short-run jobs. The MFD's warm-up time of 29 seconds brings added efficiency and reduces overall energy consumption.

* A4, short-edge feeding

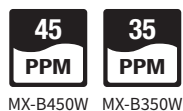

Ample Paper Capacity

A 500-sheet tray and 50-sheet multi bypass tray come standard. An optional 600-sheet paper feed unit is available for a total paper capacity of 1,150 sheets.



Accommodates Various Paper Sizes

A wide variety of paper sizes, including A6, are accommodated by the standard tray, as well as by the multi bypass tray. The optional paper feed unit and multi bypass tray handle legal-size paper and paper up to 220 g/m² thick.

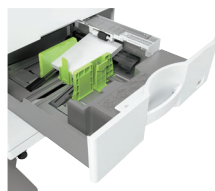

SCAN/FAX

Full-Colour Network Scanning

This MFD works as a full-colour network scanner and supports TIFF, PDF, and JPEG file formats. Converting any type of paper-based document into an editable digital file is as easy as making a copy.



Multiple Scan Destinations

You can choose different ways to distribute your scanned documents: for example, send as an e-mail attachment or scan directly to an FTP server for storage.

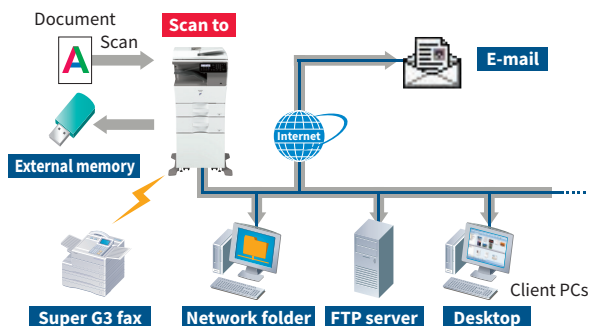

Scanner Program Keys

Scanner Program Keys on the control panel enable users to register frequently used scan settings and destinations for easy, one-touch recall.

ID Card Copy

The MFD has a dedicated key for easy copying of both sides of a card (ID cards, credit cards, etc.) onto a single page.

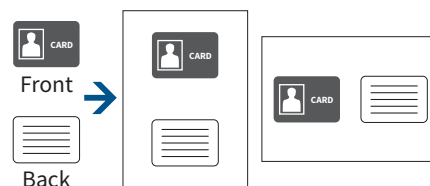

PCL 6 and PostScript® 3™

For enhanced font compatibility and improved graphics handling, the MFD supports both PCL 6 and PostScript 3.

Network Interface

Fast, powerful networking capability is provided via the 1000Base-T gigabit Ethernet standard.

Automatic Document Feeder

A standard-equipped 50-sheet RSPF (reversing single pass feeder) scans at 40 opm* (one-sided) and enables efficient duplex copying of paper sizes ranging from A4 to A6.

* Originals per minute; when feeding A4 sheets

Business Card Scanning

The MFD easily scans batches of up to 25 business cards* with its RSPF and can be used with commercially available business card scan software to create business card databases.



* One-sided scanning

Sharpdesk

With Sharpdesk integrated document management software, scanned files can be organised, edited, converted, and combined with ease. What's more, Full Text Search makes it easy to retrieve your documents.

Versatile Fax Functions

- **Super G3 Fax** function
- **PC-Fax** lets you send documents created on a PC directly to a recipient's fax machine via a phone line without printing to paper
- **Fax destination confirmation** allows users to reconfirm fax numbers before sending to prevent transmission errors
- **Inbound routing** lets you forward received faxes via the network to a shared folder or e-mail address without printing to paper
- **Speed dial keys** register up to 300 numbers

SPECIFICATIONS

General

Type	Desktop
Engine speed	A4*1: Max. 45/35 ppm
Control panel display	5-line LCD
Paper size	Max. A4, min. A6
Paper capacity (80 g/m ²)	Standard: 550 sheets (500-sheet tray and 50-sheet multi bypass tray) Maximum: 1,150 sheets (550 sheets & optional 600-sheet tray)
Paper weight	Tray 1: 60 g/m ² to 105 g/m ² Tray 2 (MX-CS14): 55 g/m ² to 220 g/m ² Multi bypass tray: 55 g/m ² to 220 g/m ²
Warm-up time*2	29 sec.
Memory	1 GB (copy/print shared)
Power requirements	Rated local AC voltage $\pm 10\%$, 50/60 Hz
Power consumption	Max. 1.84 kW (220 V to 240 V)
Dimensions (W x D x H)*3	492 x 517 x 560 mm
Weight (approx.)	29 kg

Copier

Original paper size	Max. A4
First copy time*4	8.5/9.0 sec.
Continuous copy	Max. 999 copies
Resolution	Scan: 600 x 600 dpi, 600 x 300 dpi Print: 600 x 600 dpi Equivalent to 256 levels
Gradation	Equivalent to 256 levels
Zoom range	25% to 400% (25% to 200% using RSPF) in 1% increments
Preset copy ratios	Metric: 8 ratios (4R/4E), inch: 5 ratios (3R/2E)

Network Colour Scanner

Scan method	Push scan (via control panel) Pull scan (TWAIN-compliant application)
Scan speed*5	Colour: Max. 13 originals/min. B/W: Max. 40 originals/min.
Resolution	Push scan: 100, 150, 200, 300, 400, 600 dpi Pull scan: 75, 100, 150, 200, 300, 400, 600 dpi 50 dpi to 9,600 dpi via user setting*6
File formats	TIFF, PDF, JPEG*7
Scanner utility	Sharpdesk
Scan destinations	Scan to e-mail/desktop/FTP server/network folder (SMB)/USB drive

Network Printer

Resolution	600 x 600 dpi
Interface	USB 2.0 (host, high-speed), 10Base-T/100Base-TX/1000Base-T, wireless LAN (IEEE 802.11 n/g/b)
Supported OS	Windows Server® 2008, Windows Server® 2012 R2, Windows Server® 2012, Windows Server® 2016, Windows® 7, Windows® 8.1, Windows® 10, Mac OS 10.7, 10.8, 10.9, 10.10, 10.11, 10.12, 10.13, 10.14
Network protocols	TCP/IP
Printing protocols	LPR, Raw TCP (port 9100), FTP for downloading print files, IPP, WSD
PDL	PCL 6 emulation, PostScript® 3™ emulation
Available fonts	80 fonts for PCL, 136 fonts for PostScript 3 emulation

Facsimile

Compression method	MH/MR/MMR/JBIG
Communication protocol	Super G3/G3
Transmission time	Less than 3 seconds*8
Modem speed	33,600 bps to 2,400 bps with automatic fallback
Transmission resolution	From Standard (203.2 x 97.8 dpi) to Super Fine (203.2 x 391 dpi)
Recording size	A4 to A5
Memory	64 MB (built-in)
Greyscale levels	Equivalent to 256 levels

*1: Short-edge feeding.

*2: In a standard measurement environment. May vary depending on operating conditions and environment.

*3: Including adjusters and protuberances.

*4: Short-edge feeding of A4 sheets from 1st paper tray, using document glass, MFD in fully ready condition. May vary depending on operating conditions and environment.

*5: Scan speed will vary depending on the type of document, the scan settings, operating conditions, and environment. Based on Sharp's A4 standard chart, using document feeder, short-edge feeding, one-sided scanning, and factory default settings.

*6: Resolution will vary depending on the size of the scanned area.

*7: Colour/greyscale only.

*8: Based on Sharp's standard chart with approx. 700 characters (A4 short-edge feeding) at standard resolution in Super G3 mode, 33,600 bps, JBIG compression.

• Design and specifications are subject to change without prior notice.

• PCL is a registered trademark of Hewlett-Packard Company. PostScript 3 is either a registered trademark or trademark of Adobe Systems Incorporated in the US and/or other countries. Windows Server and Windows are either registered trademarks or trademarks of Microsoft Corporation in the US and/or other countries. Mac is a trademark of Apple Inc., registered in the US and other countries. All other brand names and product names may be trademarks or registered trademarks of their respective owners.

SYSTEM CONFIGURATION

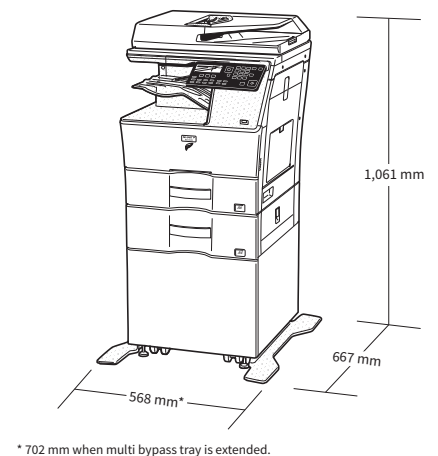
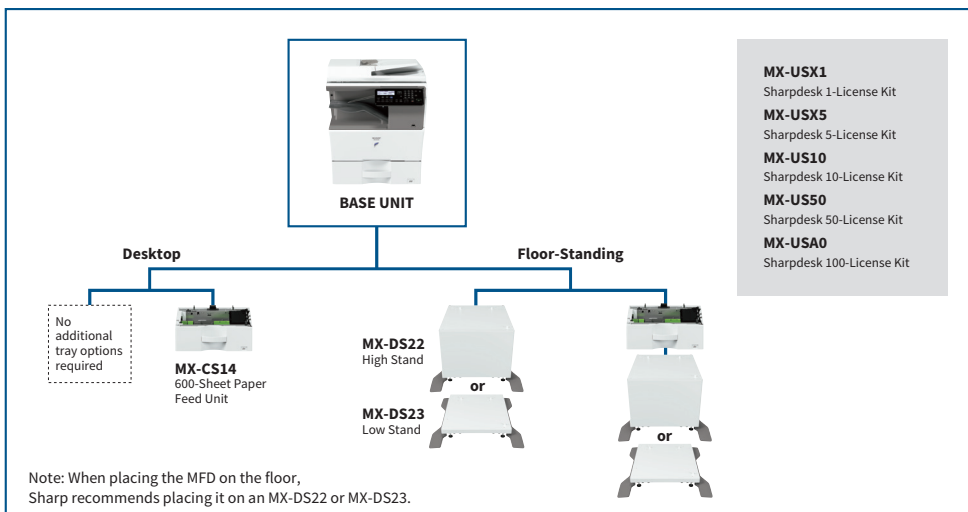

MX-B450W shown with optional equipment.

Distributed by:

SHARP

SHARP CORPORATION OF AUSTRALIA PTY LTD

ABN 40 003 039 405
P.O. Box 84, Macquarie Park, NSW 2113
Tel: (02) 9830 4600
www.sharp.net.au